

Fiche technique UT-1380 / Technical sheet UT-1380

Application	Résidentielle, Institutionnelle et Commerciale Residential, Institutional and Commercial
Usage	Moyen/Robuste — Medium/Heavy duty
Norme / Standard	Conforme—Complies with ANSI/BHMA A156.14 Grade 1

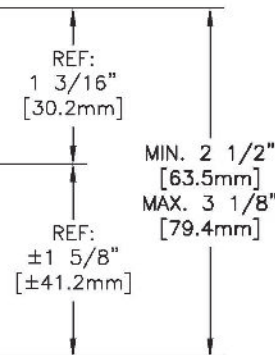

HAUTEUR DE L'OUVERTURE:
ROUGH OPENING HEIGHT:
HAUTEUR DE PORTE/DOOR HEIGHT
+2 3/4" [+70mm] MIN.
+3 5/8" [+92mm] MAX.

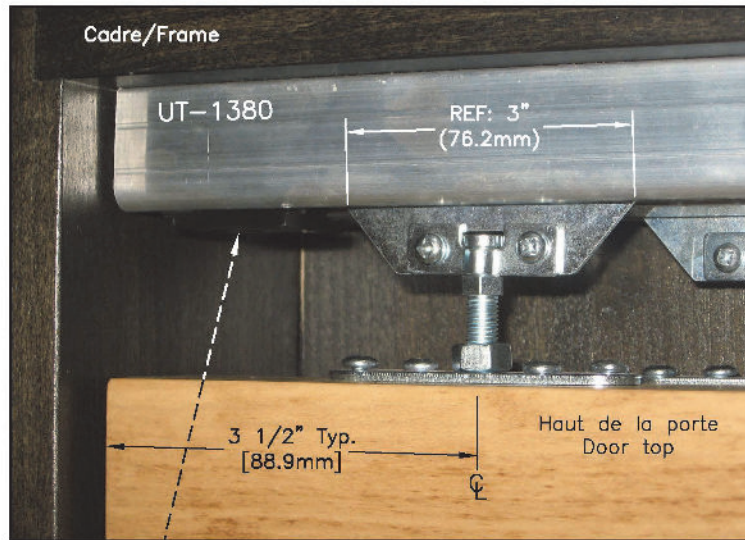
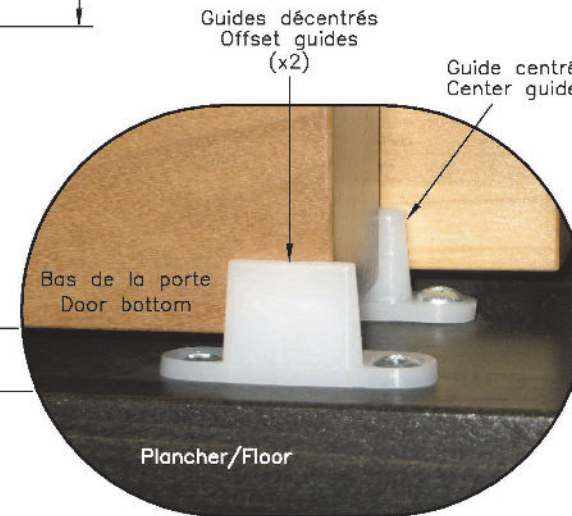
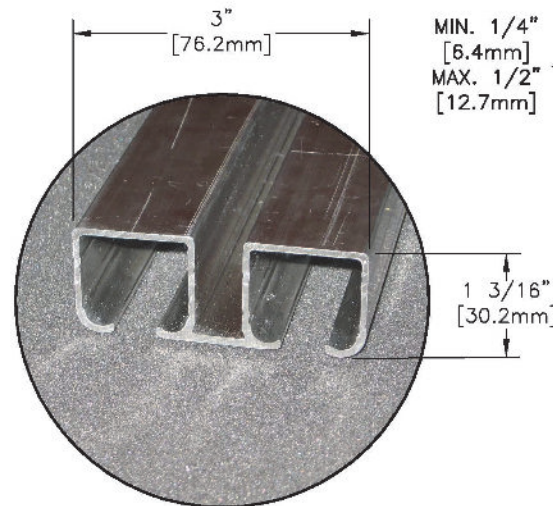
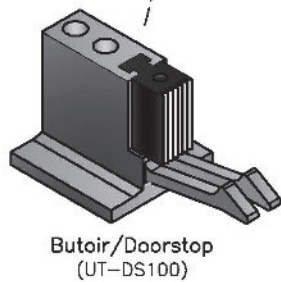

Pour 2 portes/For 2 doors 1 3/8"
de/of 125 Livres/Pounds (55Kg) Max.

Architectural **UNIQUE** Systèmes **UNITRACK** Systems
UT-1380











Votre satisfaction, notre fierté!

Dessin de référence drawing

Tél.: 514 351-5454 / Fax: 514 351-5554
uniqueproduitarchitectural.com

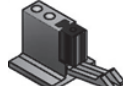
DESSIN / DRAWING No: REF-UT1380 DATE: 16/05/2014 PAGE: 1/1

CE DESSIN EST LA PROPRIÉTÉ DE PRODUITS ARCHITECTURAUX UNIQUE INC. TOUTE RÉPRODUCTION EST STRICTEMENT INTERDITE SANS CONSENTEMENT ÉCRIT.
THIS DRAWING IS THE PROPERTY OF UNIQUE ARCHITECTURAL PRODUCTS INC. ANY REPRODUCTION WITHOUT WRITTEN CONSENT IS STRICTLY PROHIBITED.

Liste des pièces ensemble UT-1380 / Parts list for UT-1380 series		
Nom/Name	Image/Picture	Qte/Qty
Rail UT-1380 Track		1
Chariot / Hanger UT-1010		4
Plaque de fixation Fixing plate		4
Guide décentré UT-1050 Offset guide UT-1050		2
Guide centré UT-1055 Center guide UT-1055		1
Écrou hexagonal 5/16" HEX nut		4
Butoir / Stop UT-DS100		4
Vis auto-perçante / Self-drilling screw #10x2"		8
Vis / Screw #10x1-1/4"		16
Vis / Screw #8x3/4"		18

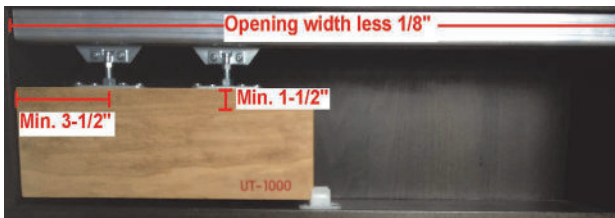

1-Cut rail 1/8" LESS than the TOTAL opening width.



2-Slide hangers UT-1010 into rail, making sure screw heads are all on the front (same) side and screw the rail into the opening's header.

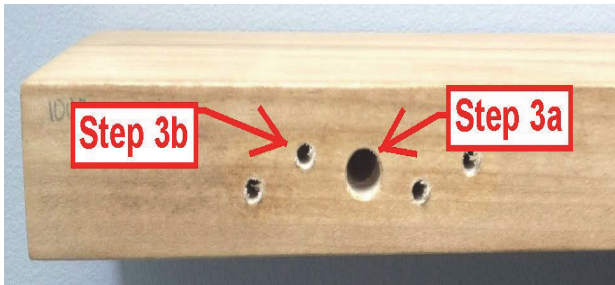

3a: Drill a 3/8" diameter hole at least 1-1/2" deep, at 3-1/2" from each end of the door.

3b: Drill 1/8" diameter holes 1" deep for the fixing plate screws.



4-Centre the fixing plate, flat side up, over the pre-drilled hole.

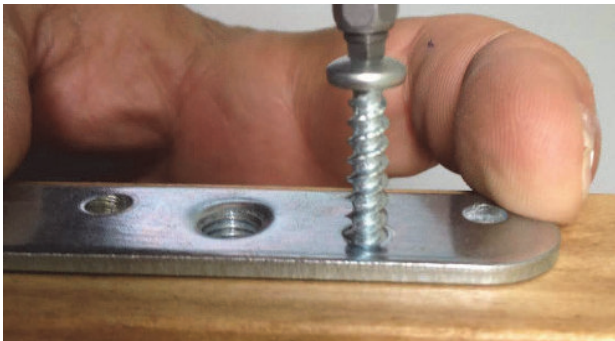

5-Screw on the fixing plates using #10 x 1-1/4" screws.

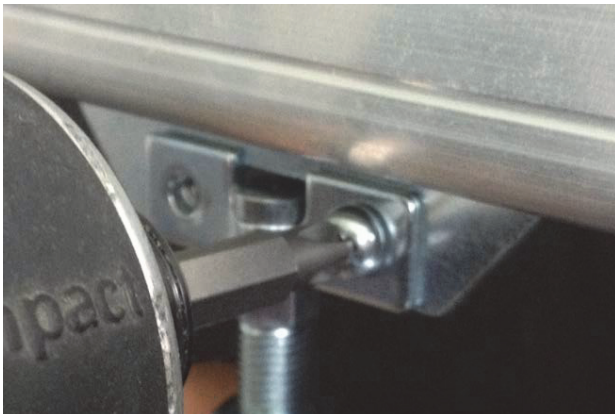

6-Unscrew the attachment plates for the fastening bolt.

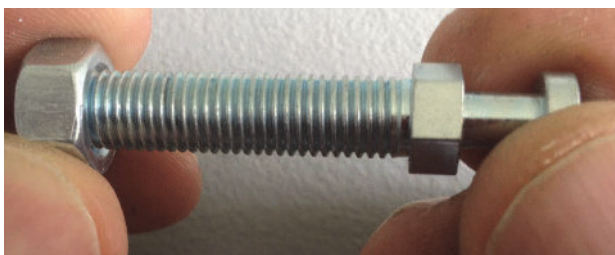

7-Screw the 5/16" hex nut onto the bolt.

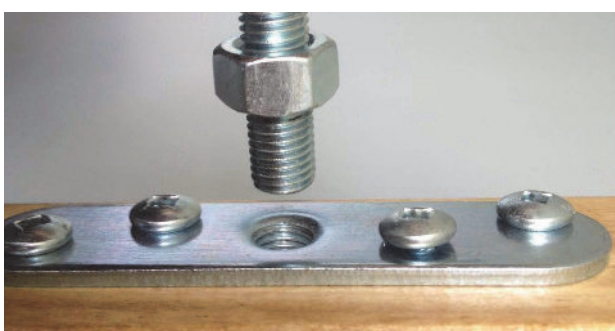

8-Screw the fastening bolt into the fixing plate.



9-Position the door under the hangers and insert the fastening bolts into the attachment sleeves.

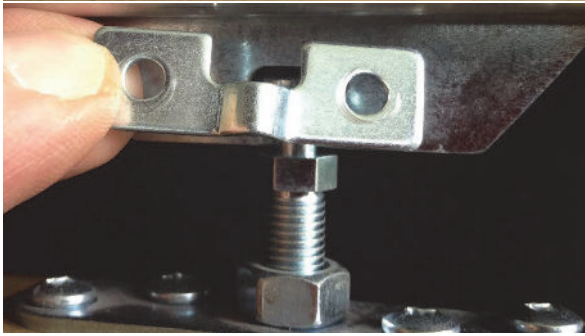

10-Re-fasten the attachment plates removed in step 6. DO NOT OVER-TIGHTEN.

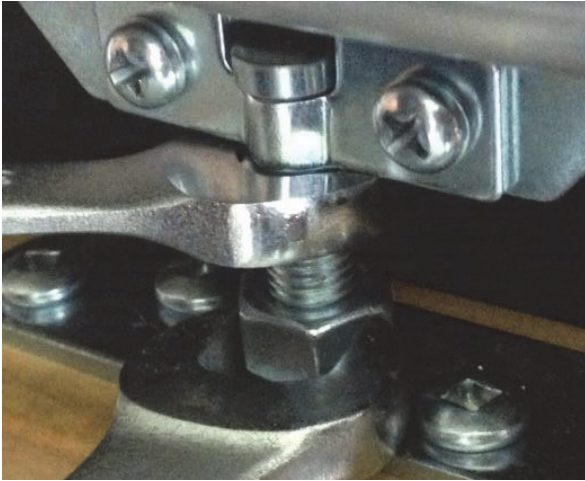

11-Set the door level and adjust its height by screwing or unscrewing the hex part of the bolt. Once adjustment is made, lock the bolt by tightening the 5/16" hex nut.













12-Place the guides UT-1050 on the floor, on the outer sides of both doors and the guide UT-1055 between the doors. Screw into place using #8 x 3/4" screws.



13-Slide the stoppers UT-DS100 into the rail at the desired stop point and attach to rail using #10 x 2" screws.

**HAUTEUR DE L'OUVERTURE:
ROUGH OPENING HEIGHT:**
HAUTEUR DE PORTE/DOOR HEIGHT
+2 3/4" [+70mm] MIN.
+3 5/8" [+92mm] MAX.

Parts list for UT-1380 series		
Name	Picture	Qty
UT-1380 Track		1
Hanger UT-1010		4
Fixing plate		4
Offset guide UT-1050		2
Center guide UT-1055		1
5/16" HEX nut		4
Stop UT-DS100		4
Self-drilling screw #10x2"		8
Screw #10x1-1/4"		16
Screw #8x3/4"		18